

TFVH • DON

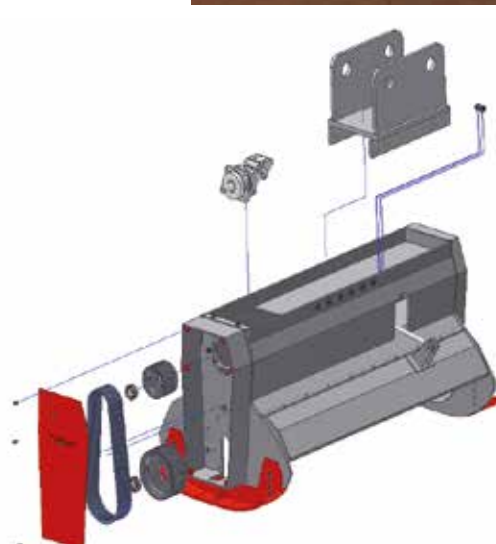

TRITURADORA FORESTAL DE MARTILLOS MÓVILES 360° EQUIPADA CON MOTOR HIDRÁULICO DE PISTONES PREPARADA PARA ADAPTAR EXCAVADORAS DE DE 20 A 35 TON. PARA TRONCOS DE HASTA Ø35CM

El bastidor de la máquina es de chapa de alto límite elástico HARDOX.

FORESTRY MULCHER WITH 360° SWINGING HAMMERS EQUIPPED WITH HYDRAULIC ENGINE OF PISTONS READY TO BE ATTACHED TO AN EXCAVATOR FROM 20 TO 35 TON. FOR LOGS UP TO Ø35CM

The machine frame is made of HARDOX high strength sheet metal.













BROYEUR FORESTIER À MARTEAUX OSCILLANTS 360° ÉQUIPÉ AVEC UN MOTEUR À PISTON HYDRAULIQUE POUR L'ACCOUPLÉMENT SUR PELLES DU 20 A 35 TON. POUR TRONCS JUSQU'À Ø35CM

Le châssis de la machine est fabriqué en tôle HARDOX à haute résistance.



Equipamiento de serie | Standard equipment | **Équipement standard**

Modelos | Model | **Modèle**

			TFVH 120	TFVH 140	TFVH 160	TFVH 180	TFVH 200
	Peso excav. Weight excav. Poids Pelle	Tn / lb	20-35 / 44.092 - 77.162	20-35 / 44.092 - 77.162	20-35 / 44.092 - 77.162	20-35 / 44.092 - 77.162	20-35 / 44.092 - 77.162
	Ancho trabajo Working Width Largeur travail	cm / inch	120 / 47	140 / 55	160 / 63	180 / 71	200 / 79
	Medidas exteriores Outer dimensions Mesures extérieures	A cm / inch B cm / inch C cm / inch	110 / 43 153 / 60 112 / 44	110 / 43 173 / 68 112 / 44	110 / 43 193 / 76 112 / 44	110 / 43 213 / 84 112 / 44	110 / 43 233 / 92 112 / 44
	Ø Rotor con martillos Ø Rotor with hammers Ø Rotor avec marteaux	cm / inch	63,5 / 25	63,5 / 25	63,5 / 25	63,5 / 25	63,5 / 25
	Ø máx. tronco Ø máx. trunc Ø max. tronc	cm / inch	35 / 14	35 / 14	35 / 14	35 / 14	35 / 14
	Martillos móviles Swinging Hammers Marteaux oscillants		16	20	24	28	32
	Peso Weight Poids	kg / lb	1.430 / 3.153	1.520 / 3.351	1.615 / 3.560	1.710 / 3.770	1.800 / 3.968
	Correas Belts Courroies	Nº	6	6	6	6	6
	Caudal aceite Oil flow Débit d'huile	l / gpm	145 / 38	155 / 41	165 / 44	175 / 46	205 / 54
	Presión Pressure Pression	BAR / PSI	200 - 260 / 2.901 - 3.771	200 - 260 / 2.901 - 3.771	200 - 260 / 2.901 - 3.771	200 - 260 / 2.901 - 3.771	200 - 260 / 2.901 - 3.771
	Protección delantera Front guard Protection frontal		Cadena doble Double chain Chaîne double				
	Patín protec. chasis Skids chasis protec. Patins protec chasis		De serie Standard De série				



PRECIO | PRICE | **PRIX**

		Martillos de widia Widia hammers Marteaux en widia
TFVH 120	25.100,00 €	25.970,00 €
TFVH 140	25.720,00 €	26.800,00 €
TFVH 160	26.780,00 €	28.080,00 €
TFVH 180	27.210,00 €	28.720,00 €
TFVH 200	30.080,00 €	31.810,00 €

Equipamiento de serie | Standard equipment | **Équipement standard**

Chapa antidesgaste rotor | Rotor with wear resistant steel | **Rotor en acier anti-usure**

Motor hidráulico de pistones | Hydraulic piston engine | **Moteur hydraulique à pistons**

Opciones | Options | **Options**

Enganche para excavadora | Connection for excavators

Accouplement pour excavateurs/pelles

1.040,00 €

Puerta trasera hidráulica | Hydraulic rear door |

Capot arrière à ouverture hydraulique

575,00 €

Motor de pistones cilindrado variable automatico | Automatic variable displacement piston engine |

Moteur à pistons à cylindrée variable autom. (75-108cc)

4.400,00 €

Electro válvula doble bobina accionamiento puerta hidráulica | Electro valve double coil

hydraulic door drive | **Entraînement de porte hydraulique à double bobine d'électrovanne**

650,00 €

Latiguillos no incluidos | Hoses not included | **Fléxibles non inclus**